

Voir la fiche technique de la pergola Equinoxe p.2

Discover the technical sheet of the urban pergola Equinoxe p.5

entdecken Sie das technische Arbeitsblatt der pergola Equinoxe p.8

atech

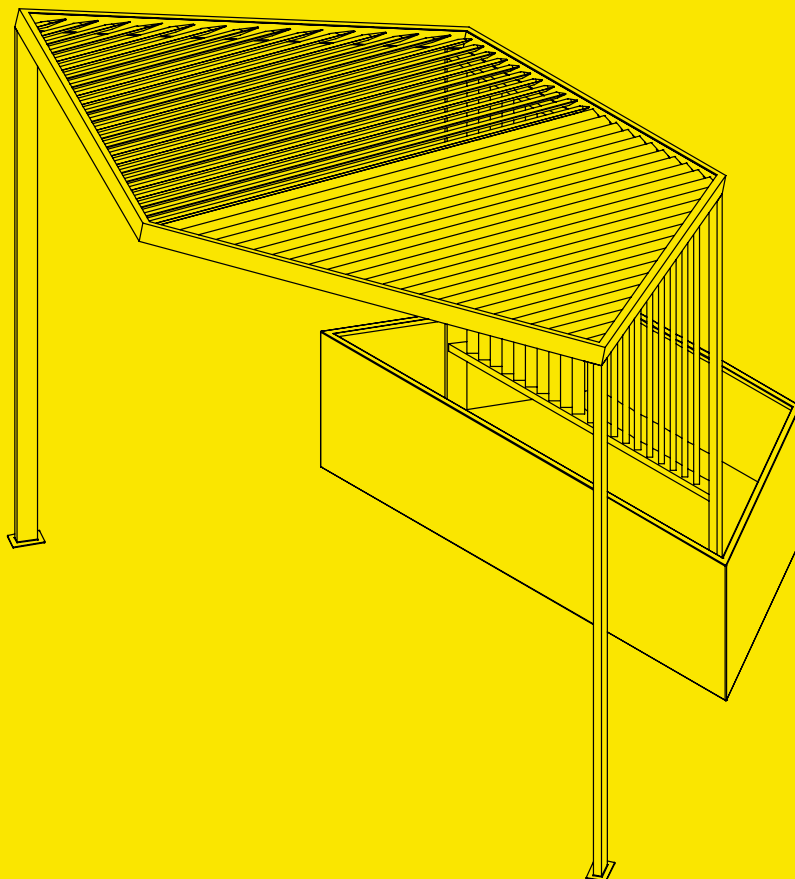

**PERGOLA
Équinoxe**

■ modèle déposé



min : 2.5 m²
max : 10 m²

Surface ombragée min : 8 m²
max : 32 m²

Contact :

info@atech-sas.com
(+33) 2 41 58 57 13

www.atech-sas.com



**aller sur
la page produit**

**demander
un devis**

JÉRÔME BOISSIÈRE

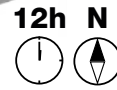
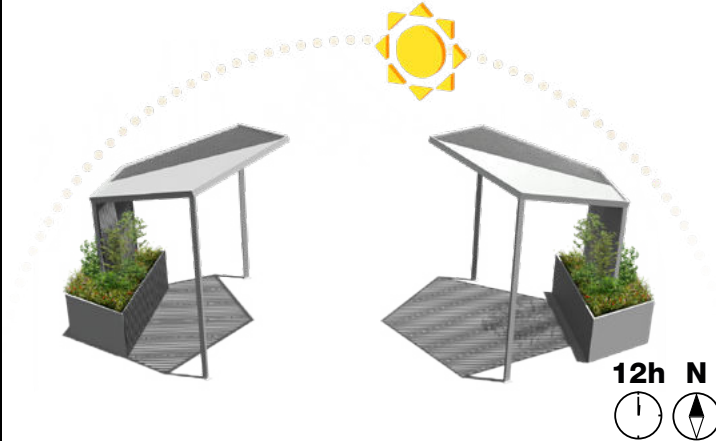

Matériaux et finitions :

- Structure aluminium ép. 3 mm, thermolaquage coloris RAL ou AkzoNobel au choix
- Système de récupération d'eau de pluie



- Réserve d'eau avec trop-plein
- avec colonnes de capillarité : tube de remplissage, réserve d'eau (copolight, géotextile anti-racinaire) avec trop plein

Fixation :

- Sur platine

Options :

- Capteur Tranquileau (2 sondes)
- Assise : Douglas brut
- Claustra : Douglas brut

**NOTRE RÉSERVE D'EAU DISPONIBLE EN OPTION
AVEC LES JARDINS URBAINS ET LES BACS SOUDÉS**

Permet de : réduire la fréquence d'arrosage, éviter les tournées inutiles et économiser l'eau

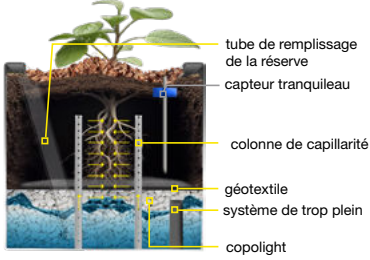

COMPOSEZ VOS AMÉNAGEMENTS

10 mm = 1m

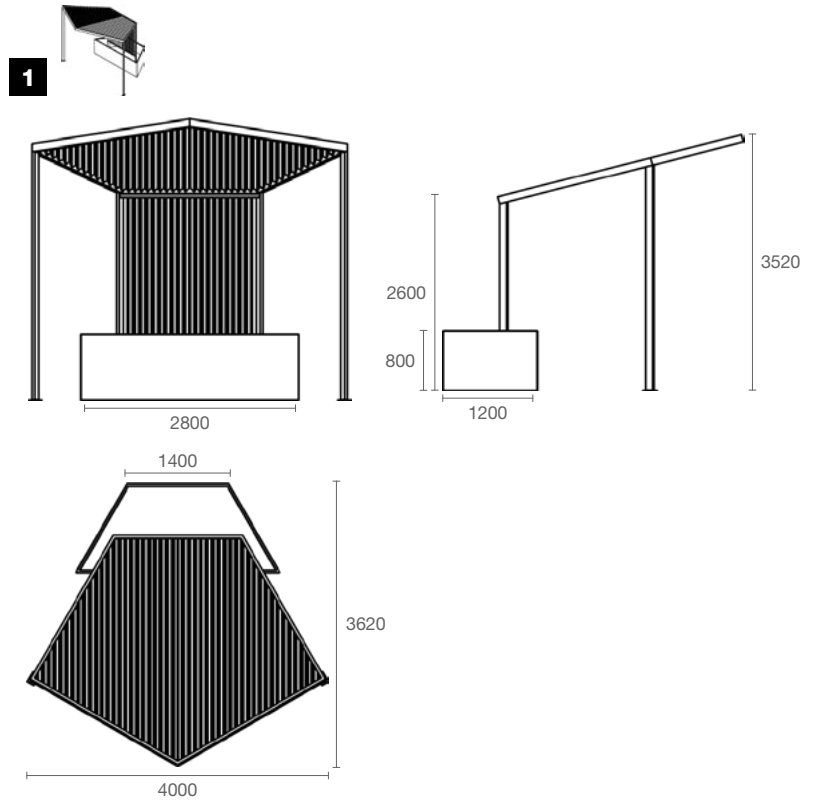

Module	1
Poids structure (Kg)	335
Surface végétalisée potentielle (M²)	2,5
Vol. substrat (L)	1500
Vol. eau (L)	500

PERGOLA
Équinoxe

■ modèle déposé

JÉRÔME BOISSIÈRE
Architecte



min : 2,5 m²
max : 10 m²

Surface ombragée min : 8 m²
max : 32 m²

Contact :

info@atech-sas.com
(+33) 2 41 58 57 13

www.atech-sas.com



aller sur
la page produit

demander
un devis



Pergolas Pentagone option assise

COMPOSEZ VOS AMÉNAGEMENTS

10 mm = 1m

A 1-1
7632 x 4000

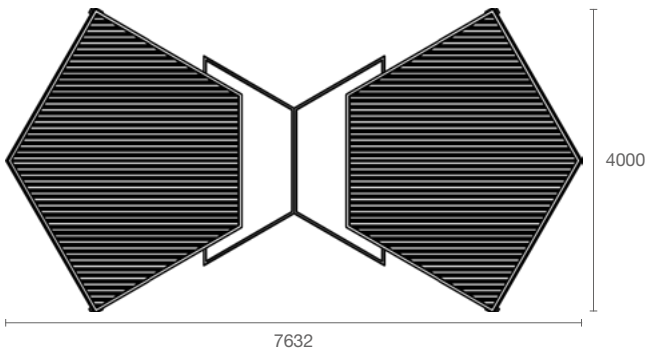
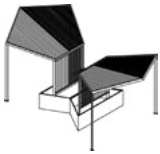

B 1-1
7600 x 4000

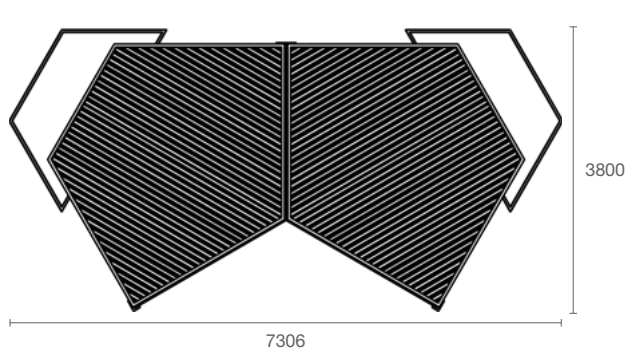

C 1-1-1
7445 x 6570

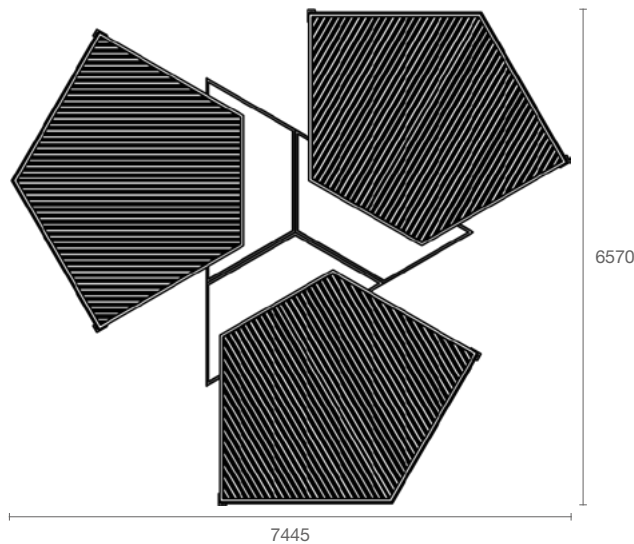
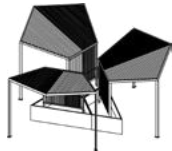

Module	1
Poids structure (Kg)	335
Surface végétalisée potentielle (M²)	2,5
Vol. substrat (L)	1500
Vol. eau (L)	500

PERGOLA
Équinoxe

■ modèle déposé

JÉRÔME BOISSIÈRE



min : 2.5 m²
max : 10 m²

Surface ombragée min : 8 m²
max : 32 m²

Contact :

info@atech-sas.com
(+33) 2 41 58 57 13

www.atech-sas.com



aller sur
la page produit

demander
un devis



Pergolas Pentagone option assise

10 mm = 1m

D 1-1-1
7600 x 7600

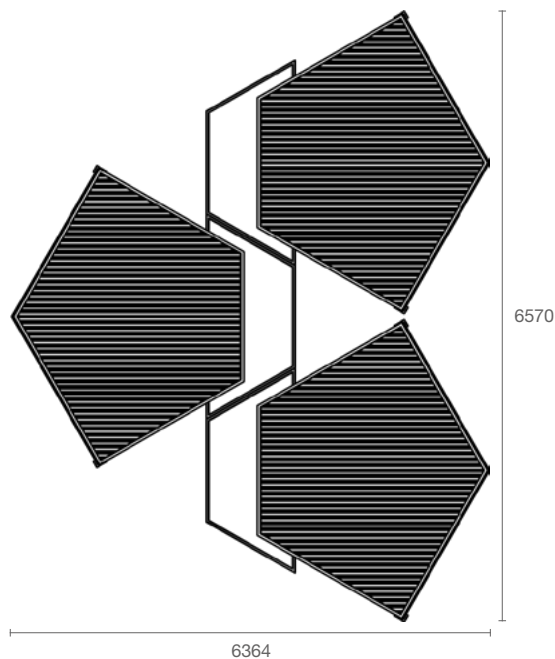
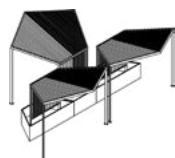

E 1-1-1-1
7600 x 7600

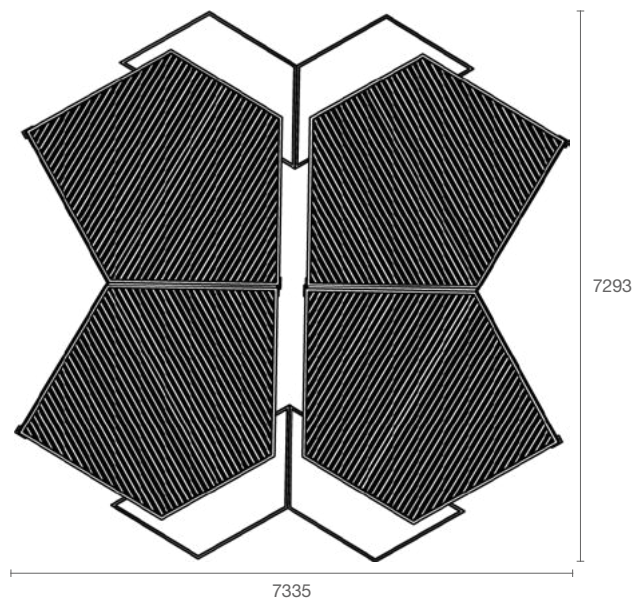

Module	1
Poids structure (Kg)	335
Surface végétalisée potentielle (M²)	2,5
Vol. substrat (L)	1500
Vol. eau (L)	500

URBAN GARDEN

Equinoxe

■ registered design



min: 2.5m²
max: 10m²

Contact:

info@atech-sas.com
(+33) 2 41 58 57 13

www.atech-sas.com



go to the
product page

ask for a quote

JÉRÔME BOISSIÈRE

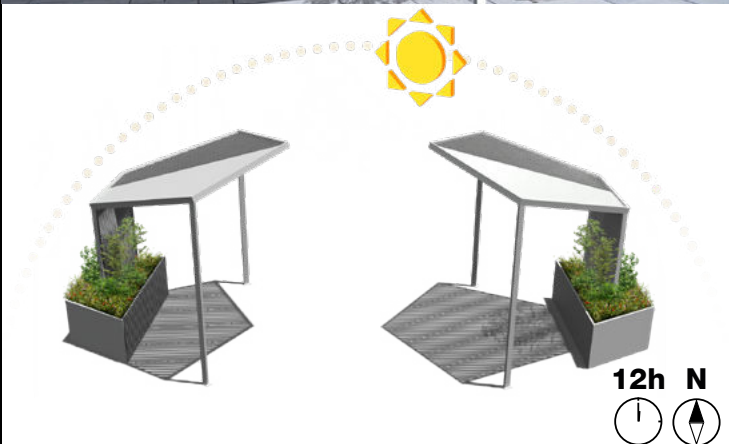

12h N

Materials and finishes:

- 3 mm thick aluminium structure, powder coated in RAL or AkzoNobel color of your choice
- Rainwater recovery system

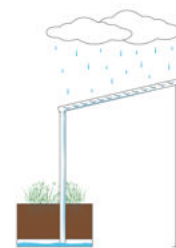

- Water Reserve with overflow system
- _ with capillarity columns : filling tube, water reserve (geotextile and copolight), with overflow system

Fixation :

- To put on the ground

Options :

- Tranquileau sensor (2 sensors)
- Seat : Douglas raw
- Panel : Douglas raw

OUR WATER RESERVE AVAILABLE IN OPTION WITH URBAN GARDENS AND WELDED PLANTERS

Allows you to: reduce watering frequency, avoid unnecessary rounds and save water

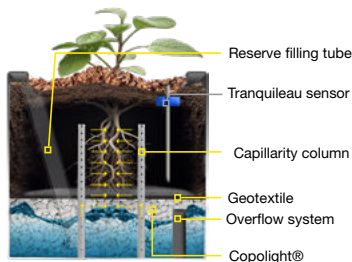

MANAGE YOUR LAYOUTS

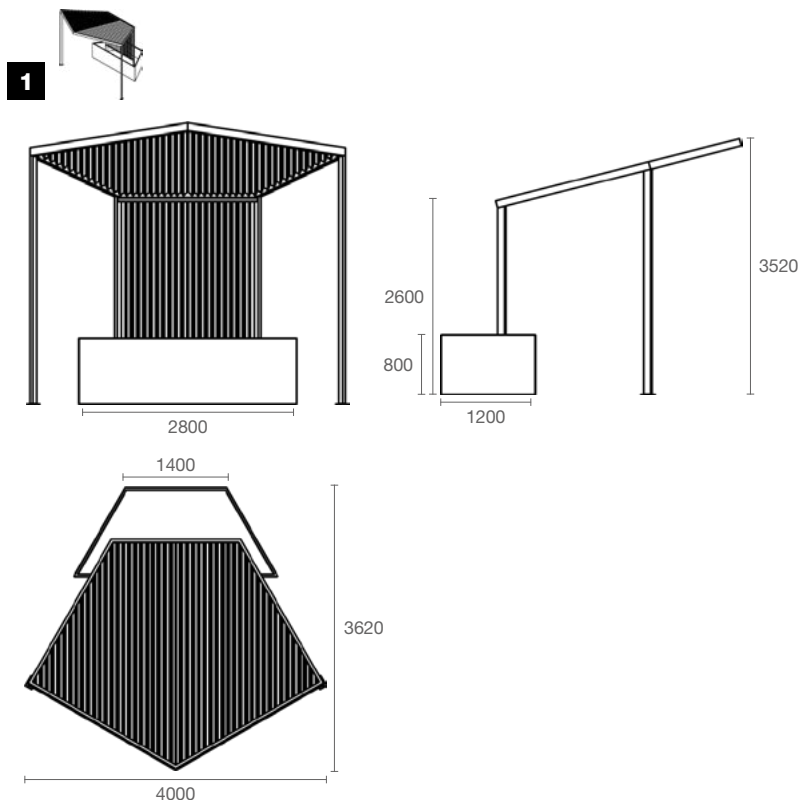

Module	1
Structure weight (Kg)	335
Potential vegetated area (M²)	2,5
Substrate vol. (L)	1500
Water vol. (L)	500

URBAN GARDEN

Equinoxe

■ registered design

JÉRÔME BOISSIÈRE



min: 2.5m²
max: 10m²

Contact:

info@atech-sas.com
(+33) 2 41 58 57 13

www.atech-sas.com



go to the
product page

ask for a quote



Pergolas Pentagone option seat

COMPOSEZ VOS AMÉNAGEMENTS

A 1-1
7632 x 4000

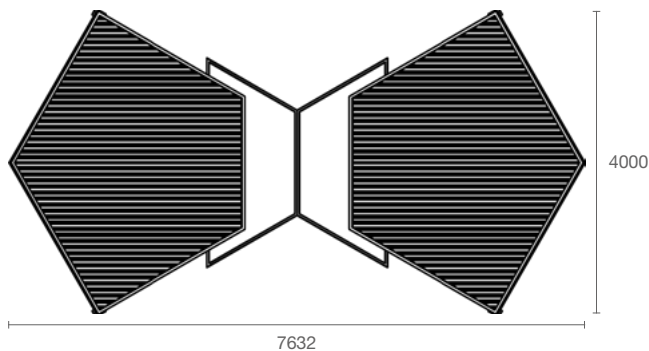
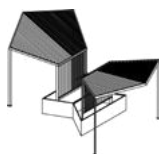

B 1-1
7600 x 4000

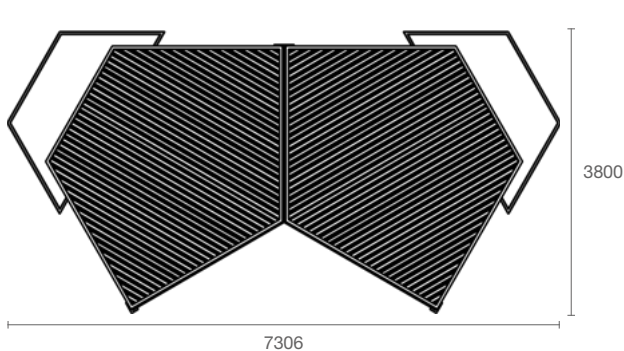

C 1-1-1
7445 x 6570

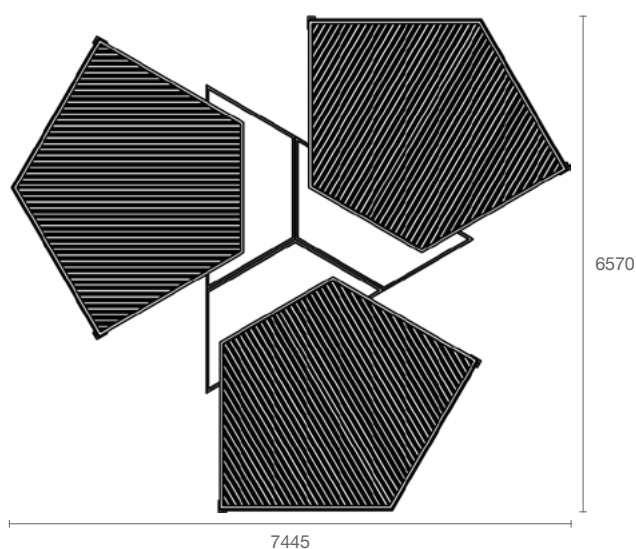
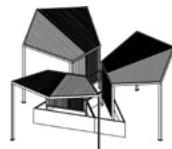

Module	1
Structure weight (Kg)	335
Potential vegetated area (M²)	2,5
Substrate vol. (L)	1500
Water vol. (L)	500

URBAN GARDEN

Equinoxe

■ registered design

JÉRÔME BOISSIÈRE



min: 2.5m²
max: 10m²

Contact:

info@atech-sas.com
(+33) 2 41 58 57 13

www.atech-sas.com



go to the product page

ask for a quote



Pergolas Pentagone option seat

D 1-1-1
7600 x 7600

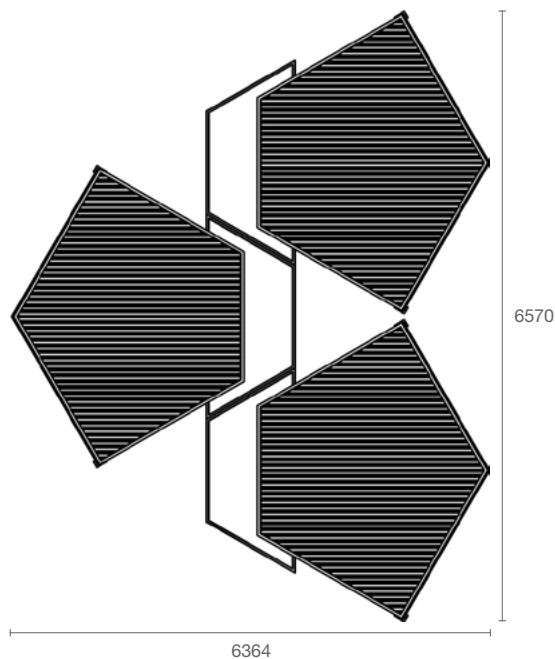
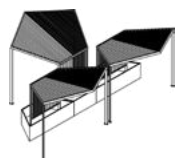

E 1-1-1-1
7600 x 7600

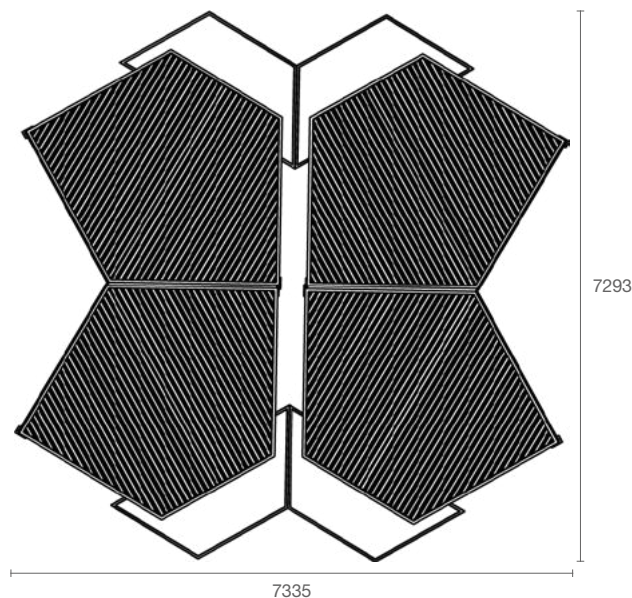
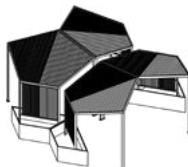

Module	1
Structure weight (Kg)	335
Potential vegetated area (M²)	2,5
Substrate vol. (L)	1500
Water vol. (L)	500

PERGOLA Équinoxe

■ Patent anmelden



min: 2.5m²
max: 10m²

Contact:

info@atech-sas.com
(+33) 2 41 58 57 13

www.atech-sas.com



Weiter zur
Produktseite

um ein
Angebot bitten

JÉRÔME BOISSIÈRE

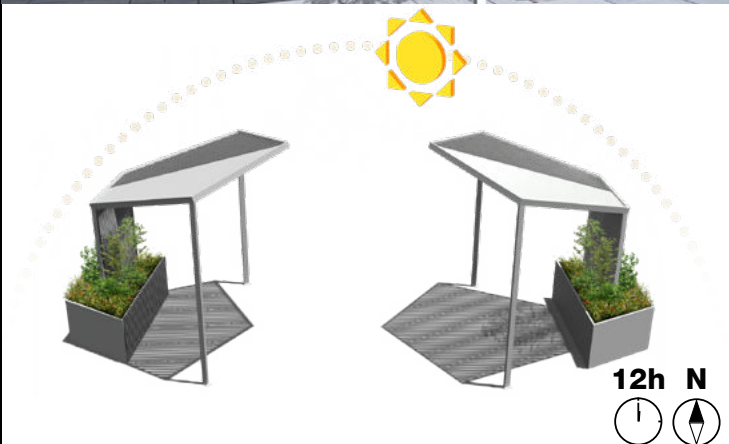

12h N
 

Material und Ausführungen:

- Aluminium Stahl, St. 3 mm, mit Korrosionsschutz behandelt und pulverbeschichtet in RAL- oder AkzoNobel-Farben nach Wahl
- Regenwassersammelsystem



- Wasserreserve mit Überlaufsystem
- mit Kapillarsäulen : Füllrohr, Wasserreserve (Geotextil und Copolight), mit Überlaufsystem
- Water Reserve with overflow system

Befestigung:

- Auf Bodenplatte oder durch Einbetonieren

Optionen:

- Wassersensoren (2 Sensoren)
- Sitzfläche: Douglasie, roh
- Claustra : Douglasie, roh

WASSERSPEICHER FÜR STADTGÄRTEN ODER VERSCHWEISSTE PFLANZKÜBEL

Ermöglicht es Ihnen, die Bewässerungshäufigkeit zu reduzieren, unnötige Runden zu vermeiden und Wasser zu sparen

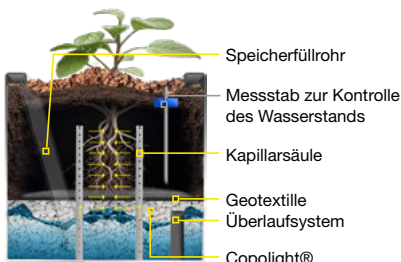

STELLE DEINE EINRICHTUNG ZUSAMMEN

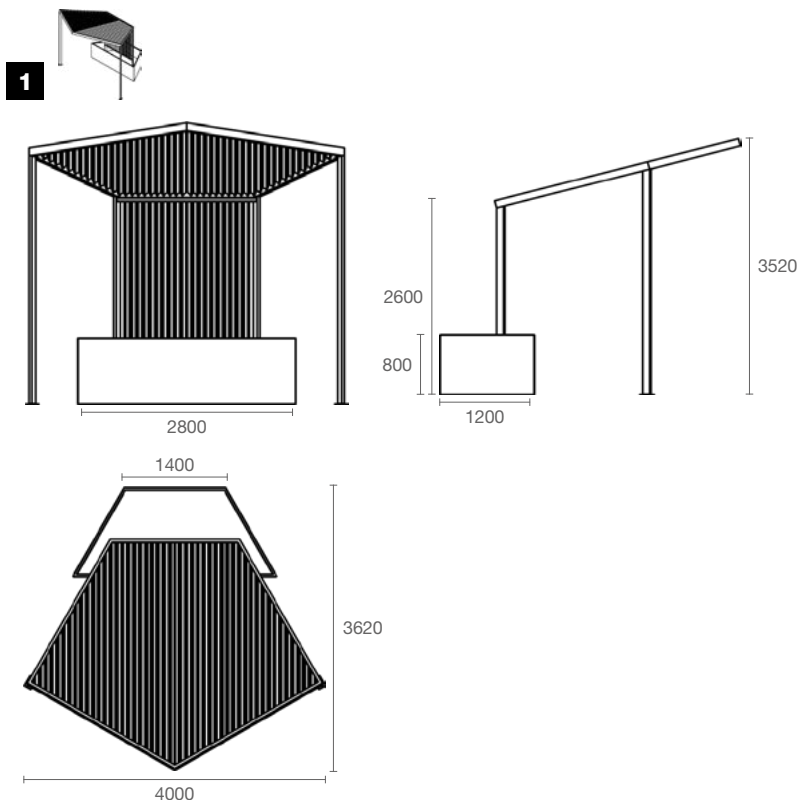

Module	1
Leergewicht (Kg)	335
Potenziell begrünte Fläche (M ²)	2,5
Substrat vol. (L)	1500
Wasser vol. (L)	500

PERGOLA
Équinoxe

■ Patent anmelden

JÉRÔME BOISSIÈRE



min: 2.5m²
max: 10m²

Contact:

info@atech-sas.com
(+33) 2 41 58 57 13

www.atech-sas.com



**Weiter zur
Produktseite**

**um ein
Angebot bitten**



Pergolen Pentagone option seat

COMPOSEZ VOS AMÉNAGEMENTS

A 1-1
7632 x 4000

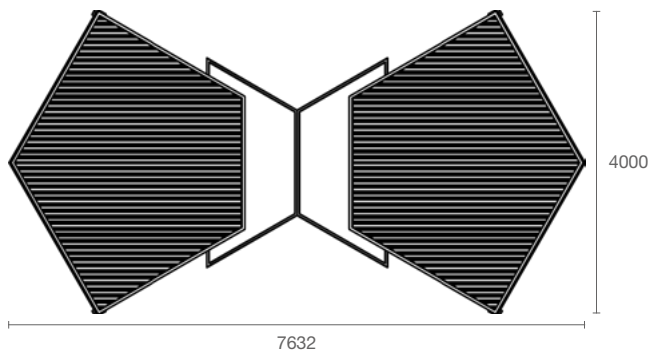
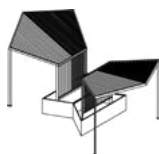

B 1-1
7600 x 4000

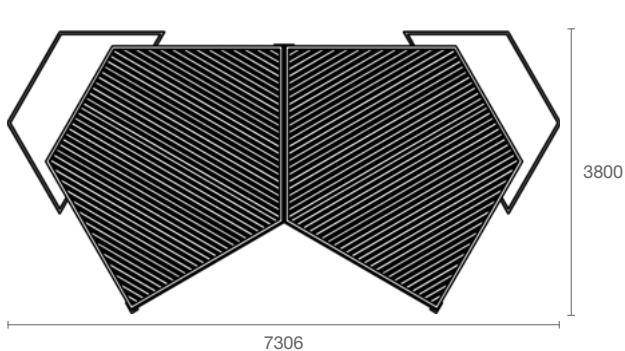

C 1-1-1
7445 x 6570

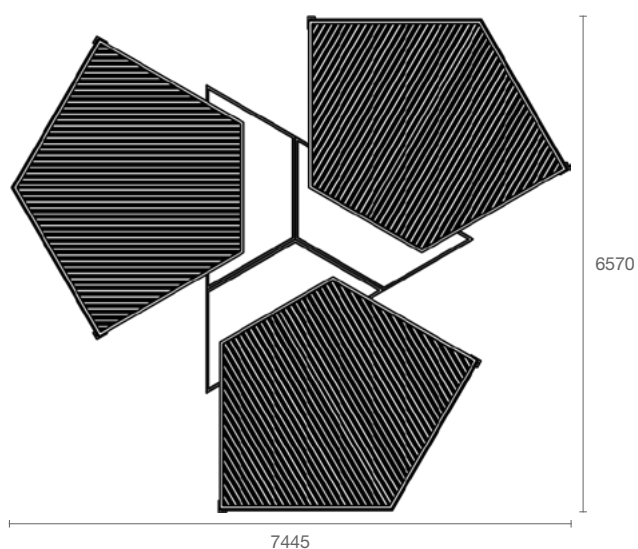
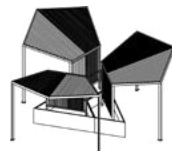

Module	1
Leergewicht (Kg)	335
Potenziell begrünte Fläche (M²)	2,5
Substrat vol. (L)	1500
Wasser vol. (L)	500

PERGOLA
Équinoxe

■ Patent anmelden

JÉRÔME BOISSIÈRE



min: 2.5m²
max: 10m²

Contact:

info@atech-sas.com
(+33) 2 41 58 57 13

www.atech-sas.com



**Weiter zur
Produktseite**

**um ein
Angebot bitten**



Pergolen Pentagone option seat

D 1-1-1
7600 x 7600

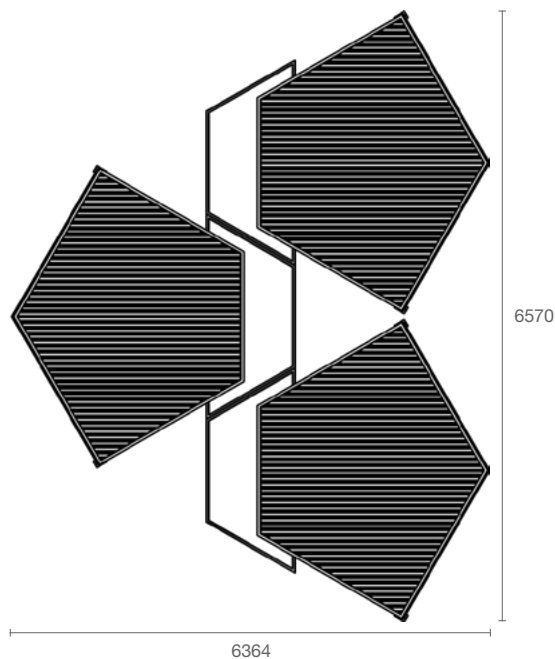
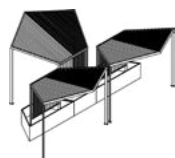

E 1-1-1-1
7600 x 7600

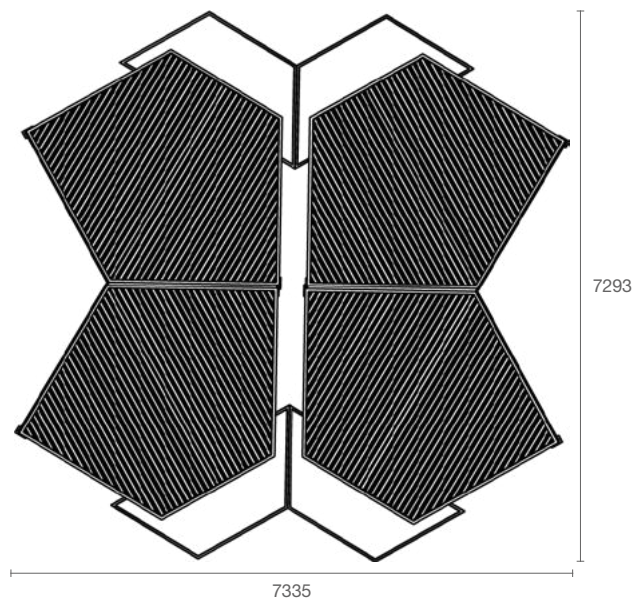
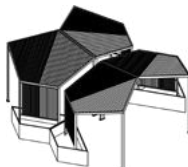

Module	1
Leergewicht (Kg)	335
Potenziell begrünte Fläche (M²)	2,5
Substrat vol. (L)	1500
Wasser vol. (L)	500