

Voir la fiche technique de l'assis debout HEDERA p.2

Discover the technical sheet of the standing seat HEDERA p.3

entdecken Sie das technische Arbeitsblatt der Stehsitz HEDERA p.4

atech

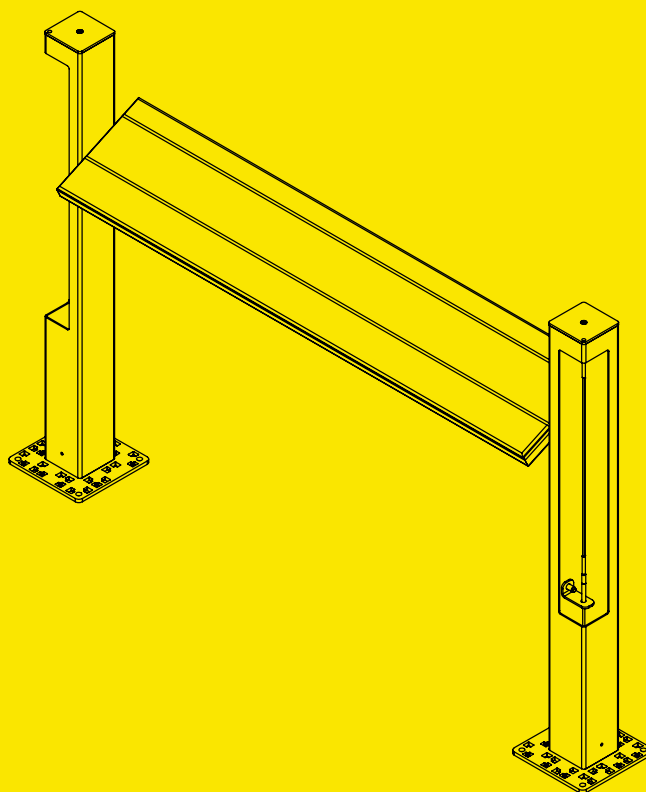

ASSIS-DEBOUT
gamme
HEDERA

Contact :
info@atech-sas.com
(+33) 2 41 58 57 13
www.atech-sas.com



**aller sur
la page produit**

**demander
un devis**



atech

Matériaux et finitions :

- Structure acier ép. 3 mm traitée anti-corrosion et thermolaquée coloris RAL ou AkzoNobel au choix
- Assise bois stratifié et rainuré ép. 8 mm coloris au choix : Afro naturel, Afro Sahara, Cerise anglaise ou Poire soleil

Fixation :

- Sur platine avec fourreau de réservation, prévoir un massif béton 500x500 mm

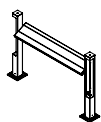

1

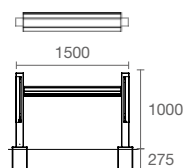

Vue de dessous

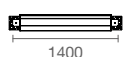

10 mm = 1m

Banc	1
Poids à vide (Kg)	52

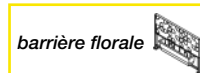
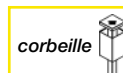

Principe de fixation

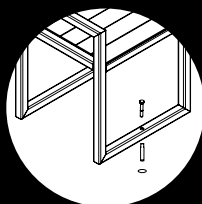

**CLIQUEZ ET DÉCOUVREZ LES
AUTRES PRODUITS DE LA GAMME**

